

Version: SUPREMA

## TECHNICAL SPECIFICATIONS:

Light source:	White LED (non-user replaceable)
Operating modes*:	M – mains and emergency operation or NM – emergency operation
Test versions*:	AT – auto test or CT – central test or CB (central battery) version
Emergency duration*:	1 h, 2 h or 3 h
Output (emergency) power*:	1 W ÷ 5 W
ESSS – battery*:	LiFePO4 6.4 V 600 mAh ÷ 4500 mAh (non-user replaceable)
Battery charging duration:	max. 24 h
Power supply*:	AT and CT: 230 V AC 50/60 Hz or CB (central battery): 230 V AC / 220 V DC
Protection class*:	II
Max. power*:	1 W ÷ 10 W
Module (& marking)*:	GS1 (AT & CT: marking EL-T or CB: marking EL)
Luminous flux*:	min. 150 lm ÷ min. 650 lm
Blue light hazard*:	Risk group RG0 (models 150), RG1 (models 250) or RG2 (models 350 ÷ 650)
Threshold distance d(thr)*:	RG0 and RG1: n.a. RG2: max. 0.5 m
Visibility:	30 m
Enclosure IP rating*:	IP44 or IP54
Ambient temperature*:	AT and CT: 10 °C ÷ 40 °C or CB: -20 °C ÷ 40 °C

\* - depending on model







## INTRODUCTION – SAFETY RECOMMENDATIONS

1. Please read this manual before installation.
2. The luminaire should be installed in accordance with its intended use and with these instructions.
3. Caution! The luminaire should be installed, maintained, and repaired by a person with appropriate qualifications. Unprofessional installation or interference in the structure of the luminaire carries the risk of electric shock.
4. It is forbidden to modify the luminaire or install it in a manner inconsistent with the methods approved by the manufacturer.
5. The manufacturer does not guarantee the proper operation of the luminaire and is not responsible for any potential damage or personal injury resulting from installation, maintenance or repair performed contrary to this manual, generally accepted principles of installation, occupational health, and safety rules, intended use or when the installation was performed by a person without appropriate authorisations.
6. The luminaire should be installed when power supply is off. Safety rules, construction and electrical installation standards should be followed all the time.
7. When connecting the luminaire to the mains network, make sure that the power supply parameters correspond to the rated ones. In models with class I protection, the protective conductor must be wired. After connecting the power supply, the luminaire is energized.
8. When installing a luminaire operating in maintained mode, the L and L1 terminals must be connected to the same phase. For non-maintained mode, the L1 terminal must remain unconnected.
9. The luminaire should not be powered with circuits connected to inductive power-receiving devices at the same time. This type of solution may cause damage to the electronic module of the luminaire.
10. Caution! Possibly hazardous optical radiance emitted from product. Do not stare at operating lamp. Staring from a close distance may be harmful to the eye. The luminaire should be positioned so that prolonged staring into the luminaire at a distance closer than d(thr) is not expected (the d(thr) value is given in the table on the first page of the manual, if applicable).
11. The luminaire should be used indoors.
12. The luminaire should be mounted in a way that allows natural heat dissipation, covering the device is not allowed. During installation, the luminaire should not be covered with thermally insulated material.
13. Do not touch the device with wet or damp hands or objects.
14. In case of suspicion of damage to the electrical part of the device (supply circuit, light source, power wires or connector) or to any part of the housing, do not use the luminaire.
15. Cardboard or paper packaging parts should be disposed of as wastepaper or thrown into a paper container for recycling, while plastic packaging into a container for plastic waste.
16. Obsolete luminaire (or its parts) cannot be disposed of as a regular waste but should be delivered to special WEEE collecting points (for electric and electronic equipment and batteries).

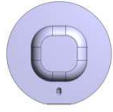

1. Before installation make sure that the luminaire will be connected to 230 V AC power supply using minimum a 1.5 mm<sup>2</sup> wire and that the cable can be passed through the cable gland.
2. The luminaire, depending on its version, can be installed in several ways.
3. Surface anti-panic models can be installed on a surface on a ceiling or a wall, for these ways no additional accessories are needed (only screws and plugs are necessary). Surface directional models can also be installed on a ceiling without any additional accessories.
4. The models mentioned in point 3 can be also installed on a wall, as flags or suspended from a ceiling. These installation ways require additional dedicated accessories.
5. Recessed anti-panic and directional models can be installed in a recessed ceiling without any additional accessories.
6. If the luminaire is installed as a directional one, appropriate pictograms should be attached to the light guide plate. Due to the convenience and accuracy of the operation, it is recommended to stick them on before starting the assembly.
7. For a surface installation, using a delivered installation template, prepare holes and plugs that will be used for a luminaire's base fixing to a ceiling, as well as assure that a power cable can pass through by a chosen cable entry.
8. In order to install the luminaire on a ceiling, one need first to open the housing by pressing on two latches on its ends (see drawings: part I), then to conduct the power cable through one of two cable entries available (see drawings: part II / part III), then to fix the housing base / mounting plate to a ceiling by means of screws (see drawings: part IV).
9. For models to be installed in a recessed ceiling, one need first to make a hole in the ceiling using the attached template (see drawings: part VII/1), printed on packaging. Installation is being done by means of dedicated springs mounted at ends of a housing's body (see drawings: part VII/2-5).
10. When installing the luminaire make sure that its orientation reflects its function related to the built-in optics, see below:

OPTICS	SO	SQ	SOH	SC	SCH	SP
APPLICATION	Open space	Square open space	High open space	Corridor	High corridor	Safety point
ORIENTATION	Inessential (optics fully symmetrical)	Square shape reflects square area	Inessential (optics fully symmetrical)	Arrows along the corridor	Arrows along the corridor	Arrow showing the safety point
PICTURE OF THE OPTICS (WITH MARKED ORIENTATION, IF ESSENTIAL)						

11. Connect all the wires of a prepared power cable to the appropriate terminal block entries (see: page 3, part V).  
The description of luminaire's terminals:  
**L** – for permanent phase wire - brown or black insulation colour; power source for battery charging, presence signalled by signal LED lighting up in green; the luminaire should be continuously powered from the permanent L phase;  
**L1** – a terminal to be optionally used for a wall switch connection, enabling to switch a luminaire off during M/SA mode operation, if no switch is used the terminal L1 should be connected to a phase wire in parallel with the L terminal;  
**N** – neutral wire - blue insulation colour.
12. Luminaire designed for **EMERGENCY operation (NM)** requires wiring AC supply to following terminals: **L** (phase) and **N** (neutral).
13. Luminaire designed for **MAINS AND EMERGENCY operation (M)** requires wiring **L** and **N** according to previous point and additionally connecting **L1**. For a simple M operation **L1** terminal should be permanently shorted to **L** terminal. It can be also optionally connected through a wall switch (still to the same phase), enabling switching the luminaire off for a time (the luminaire stays ready for an emergency operation).
14. Before switching the mains supply on, connect the battery – insert the white battery plug into the socket on the PCB.
15. Please remember to write the installation date on the label attached to the battery pack.
16. To complete the installation, one need to click the luminaire's body (with light guide plate for directional models) into the base / mounting plate (see: page 4, part VI).
17. Test for correct operation - turn on the AC power. The green LED indicator should light up to indicate connection to the AC network and battery charging. After charging, the LED indicator should remain green all the time, which means that the luminaire is ready to operate in emergency mode. By pressing the test button, it's possible to check whether the luminaire enters the emergency operation when the power supply is off. The way how to press the test button and how to read the luminaire's behaviour depends on its version. Please refer to the detailed description in the "TESTING" section.
18. Before using the luminaire, the battery pack must be properly formatted. During formatting, do not perform any tests or disconnect the power in any other way than indicated. The first charging of the battery pack should last continuously for at least 48 hours. After 48 hours, disconnect the power supply and allow the luminaire to operate in emergency for its entire rated time, then reconnect the power supply for at least 36 hours. After charging, discharge the luminaire again for at least its declared rated duration. Then connect the power supply again for min. 24 hours. This sequence completes the formatting cycle, and the luminaire is ready for use.

I. DISASSEMBLY

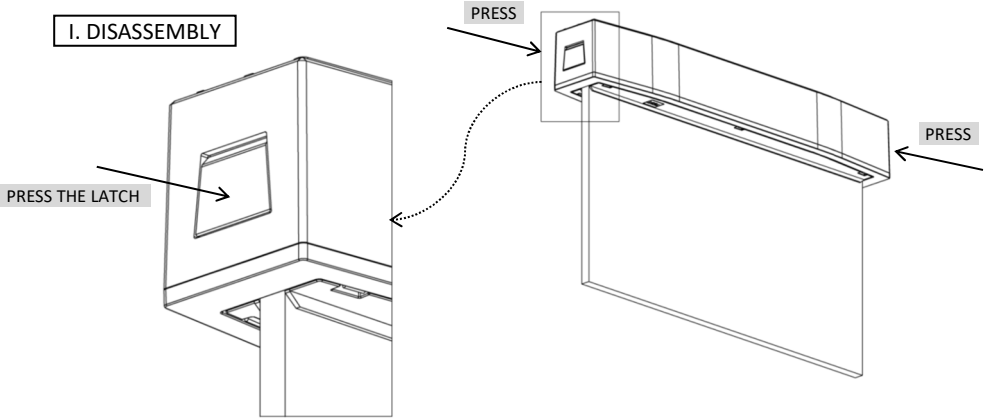

II. MAKING A HOLE FOR A CABLE ENTRY

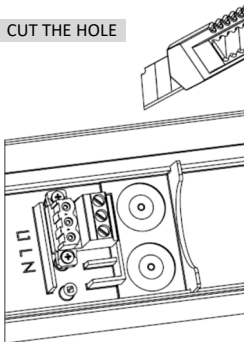

III. PASSING A POWER CABLE

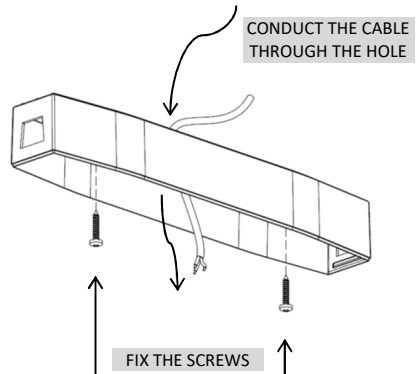

IV. FIXING TO A CEILING

V. CONNECTING THE POWER WIRES

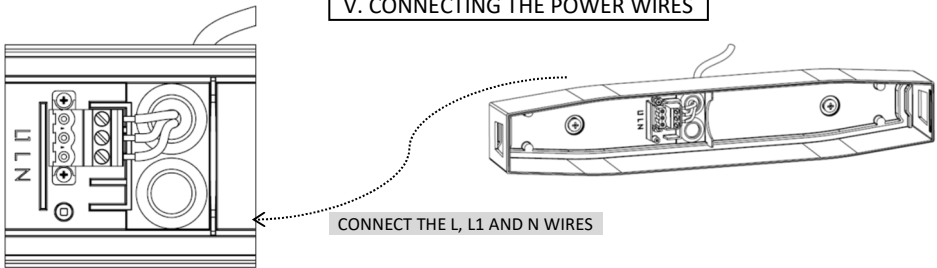

## VI. CONNECTING THE LUMINAIRE WITH THE BASE

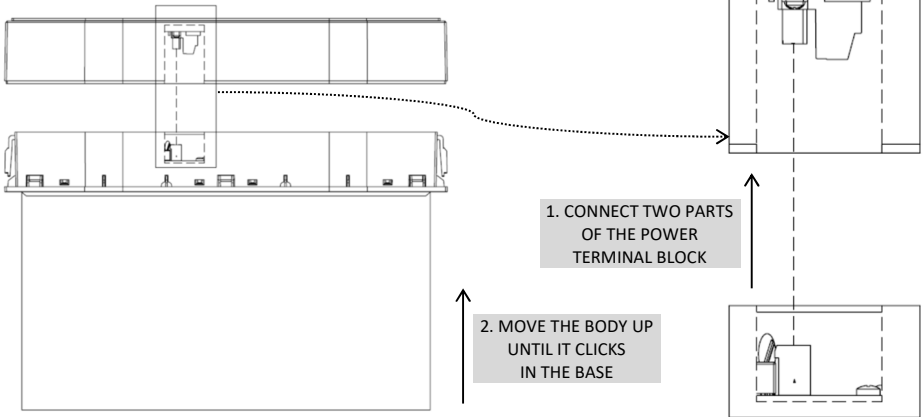

## VII. INSTALLING A RECESSED VERSION

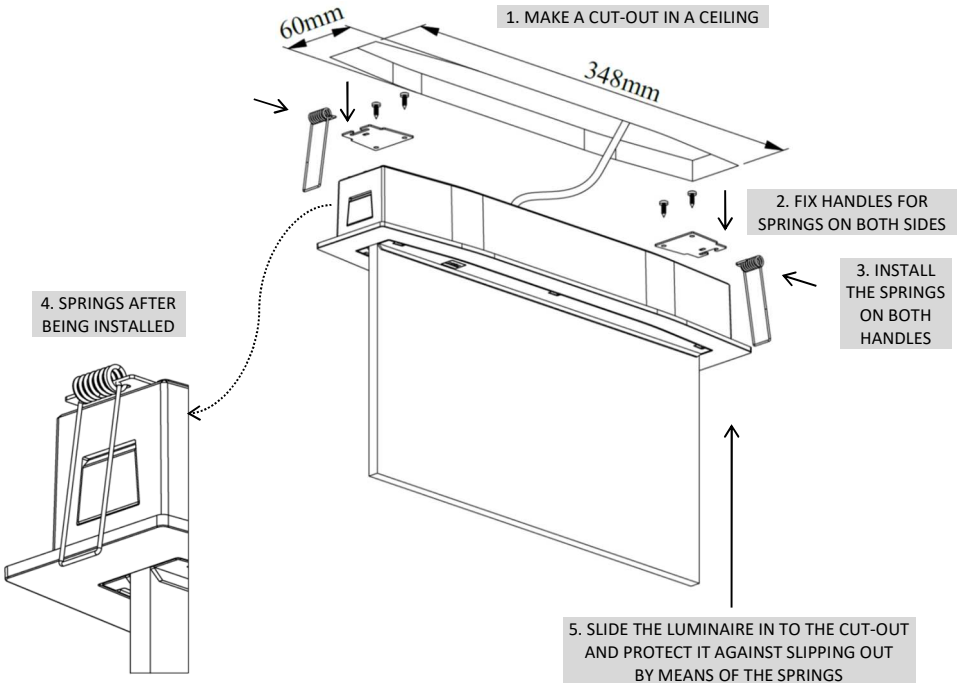

## LUMINAIRE OPERATION

Correct operation requires a continuous connection to 230V AC mains network (L terminal). Correct operation of the device is confirmed by LED indicator lighting up in green. The battery is being continuously charged / trickle charged for the purpose of a possible emergency operation. When AC power supply is off (no voltage on L), the luminaire automatically starts operating in emergency mode and the source of light is activated for the period specific for a particular model. During emergency operation, the green LED indicator is off.

### EMERGENCY OPERATION MODE (NM)

Requires wiring of L and N terminals. In this mode during AC supply the luminaire does not light. When AC supply is off, the luminaire automatically starts operating in emergency mode and the light source is supplied from a battery pack.

### MAINS AND EMERGENCY OPERATION MODE (M)

Requires wiring of L, L1 and N terminals. In this mode during AC supply the luminaire lights up. When AC supply is off, the luminaire automatically starts operating in emergency mode and the supply of light source is switched from mains to battery pack.

NOTE! In a case of M luminaire version, but wired as NM one, it behaves according to NM typical behaviour.

### BATTERY PACK

The luminaire is equipped with a rechargeable lithium-iron-phosphate LiFePO<sub>4</sub> battery pack. Please remember to carry out the correct first-time charge cycle (see last point in "INSTALLATION"). After such a formatting cycle it achieves its capacity and is prepared to perform a possible full time emergency operation. It is suggested to discharge and then to re-charge the battery every three months, even if it hasn't been used, to extend its performance. It is recommended to replace the battery once every four years of operation or in a case of poor test results. Obsolete batteries, similarly to packaging, fluorescent lamps or electronics, are recyclable products that should be disposed to a recyclable waste collection point.

## NORMATIVE TESTING – REQUIREMENTS

The luminaire should be tested on regular basis in accordance with valid laws and regulations. The results of the tests should be recorded and stored for the use of a fire safety inspector. For AT and CT versions is being performed automatically, according to programmed cycles.

### ONCE DAILY

It is suggested to check visually if the LED indicator in the luminaire lights up in green.

### ONCE MONTHLY

It is necessary to perform a function test by disconnecting the AC power supply and checking whether the luminaire is operating in emergency mode - the green LED indicator should turn off, and LED light source light up.

### ONCE YEARLY

It is necessary to perform a duration test by disconnect the AC power supply and checking if the luminaire operates in emergency mode for a specified time. If the autonomy time of emergency operation is not sufficient, the ESSS (e.g. battery) needs to be fully recharged, and the test is to be carried out again. If the result of the test continues to be negative, the battery needs to be replaced.

## TESTING – TIPS

### BASIC INFORMATION

TESTING OPTIONS	MT	AT	CT	CB
AVAILABLE MODELS	---	YES	YES	YES
TEST BUTTON	---	YES (1)	YES (1)	---
GREEN INDICATOR	---	YES	YES	YES
RED INDICATOR	---	YES	YES	---

Test button: (1) – external, as a proximity switch on the housing

### AUTO TEST (AT)

The test button in AT and CT models can be optionally used for manual tests' initiations. It enables to check the readiness for emergency operation at any time, apart from planned tests. When the luminaire is connected to mains network and there is no voltage drop, pressing and holding the test button, depending on time of pressing, will result in activation of any of the two. Pressing the button for  $2s < t < 5s$  initiates the function test, for  $10s < t < 15s$  initiates the autonomy test. For a convenient counting of seconds – when a test button is pressed and hold – after every second the luminaire confirms the passing time by a quick flash of a red indication LED. When the luminaire is during any (manually initiated) test procedure, pressing the button for a time  $t > 10s$  – breaks any currently running test.

Note 1 – If such an optional test is finished less than 24h before any planned test, the planned test will be delayed in order to achieve full 24h battery charging time. The delay will be applied also in a case of mains failure and its restoration at the moment that is closer than 24h before such a planned test.

Note 2 – Automatic normative tests cannot be interrupted!

Note 3 – During emergency operation (mains failure) the test button is inactive!

During a standard luminaire's operation, both functional and autonomy tests are being initialised automatically. After installation and connection of the mains network the luminaire randomly chooses its testing schedule. The first functional test will be performed within the first month of installation, then it will be automatically repeated every 28 days. The first duration test will be performed within the first year of installation, then it will be repeated every 340 days.

It is not possible to erase any test results, which means that any signalled failures will be cancelled only after the luminaire has been repaired.

IMPORTANT - if a power failure occurs during the test, the luminaire will interrupt the test and then switch to emergency operation. After the emergency operation ends and the power supply returns, the luminaire will not signal any results of the interrupted test (the green LED will be lit as in the basic state). The interrupted scheduled test (unless more than 7 days have passed since the power failure) will be repeated after min. 24 hours from the return of power. A manually initiated test will not be repeated.

All possible AT luminaire operating states and its LED signals are gathered in the table below.

LUMINAIRE WORKING STATE OR ACTION	GREEN LED INDICATION	RED LED INDICATION	COMMENTS
<b>BASIC STATES</b>			
MAINS SUPPLY ON, BATTERY BEING CHARGED	ON	OFF	
MAINS SUPPLY FAILURE, BATTERY OPERATION	OFF	OFF	
<b>FUNCTIONAL TEST STATES</b>			
FUNCTIONAL TEST – PART 1 (LIGHT SOURCE AND ELECTRONICS)	OFF	FLASHING (1/T2)	DURATION: 60s
FUNCTIONAL TEST – PART 2 (CHARGING CIRCUIT)	ON	FLASHING (2/T1)	DURATION: 10s
CHARGING, ELECTRONICS, LIGHT SOURCE OR BATTERY FAILURE	ON	ON	
LUMINAIRE (ELECTRONICS, BATTERY, LIGHT SOURCE) – OK	ON	OFF	
<b>DURATION TEST STATES</b>			
DURATION TEST – PART 1 (LIGHT SOURCE, ELECTRONICS AND DURATION)	OFF	FLASHING (2/T2)	DURATION: 1h, 2h, or 3h (*)
DURATION TEST – PART 2 (CHARGING CIRCUIT)	ON	FLASHING (2/T1)	DURATION: 10s
CHARGING, ELECTRONICS, LED SOURCE, BATTERY OR DURATION FAILURE	ON	ON	
LUMINAIRE (ELECTRONICS, BATTERY, DURATION, LIGHT SOURCE) – OK	ON	OFF	
<b>TEST BUTTON FUNCTIONS</b>			
FUNCTIONAL TEST INITIATION – PRESS THE BUTTON FOR $2s < t < 5s$	ON	FLASHING (1/T)	FLASHING
DURATION TEST INITIATION – PRESS THE BUTTON FOR $10s < t < 15s$	ON	FLASHING (1/T)	ALLOWS TIME (t)
BREAKING OFF ANY TEST (**) – PRESS THE BUTTON FOR $t > 10s$	FLASHING (5/T)	FLASHING (***)	COUNTING

$T$  – 1s period;  $T2$  – 10s period;  $t$  – time of pressing the test button

FLASHING: (1/T) / (2/T1) / (5/T) – 1 flash / 2 flashes / 5 flashes every 1s period

FLASHING: (1/T2) / (2/T2) – 1 flash / 2 flashes every 10s period

(\*): test duration is same as an autonomy time declared for a given luminaire

(\*\*): automatic normative tests cannot be interrupted, it concerns solely manual tests

(\*\*\*): signalling depends on a test being executed at the moment, as in a given test

### CENTRAL TEST (CT)

This version in a basic make is designed for co-operation with a WELLS wireless central monitoring system. All control possibilities are described in a separate instruction manual dedicated for WELLS system. Signalling ways of all luminaire's states and tests' schedules and results are identical to those described for AT version. An additional state is the "UNBOUND" signal which means that a luminaire is not (temporarily or permanently) in a communication contact with a control unit:

LUMINAIRE WORKING STATE OR ACTION	GREEN LED INDICATION	RED LED INDICATION	COMMENTS
<b>WELLS COMMUNICATION STATES</b>			
"UNBOUND" SIGNAL, 24h AFTER LOSS OF COMMUNICATION WITH A CENTRAL UNIT	FLASHING (6/T2)	FLASHING (6/T2)	SIMULTANEOUS

FLASHING (6/T2) – 6 quick consecutive simultaneous pairs of green LED and red LED flashes, repeated in a 10s period, the sequences interrupt signalling of a basic luminaire's state (according to the table described for AT)

IMPORTANT – for a luminaire not connected with a central unit (wireless network) it means only no connection between the luminaire and the central unit. The luminaire can be still working correctly, performing planned tests and signalling their results on signal LEDs, assuring safety of a building, but tests' results are not being transferred to a central unit.

### CENTRAL BATTERY (CB)

CB version is being monitored directly by a central battery system controller, in a way depending on such system's possibilities and settings.

## FAULTY OPERATION AND ITS POSSIBLE DIAGNOSIS

### GREEN LED INDICATOR IS OFF

AC power failure.

### RED LED INDICATOR IS ON

For AT and CT models it can mean that one of a luminaire's elements (a charging circuit, a light source supply circuit, a light source itself or a battery) is damaged or a duration time in an emergency mode is too short. It is recommended to repeat the test and - in a case of confirmation of bad results - to call a service team. For more information, please, refer to the "TESTING – TIPS" section.

### RED LED INDICATOR FLASHES

The luminaire performs testing. Please, refer to the "TESTING – TIPS" section.

### INSUFFICIENT DURATION

It is possible that the battery requires a full charge cycle (24 h). If after 24 hours of charging the luminaire still does not keep a predefined duration, it is possible that the battery is run-down or damaged, e.g. due to possible incorrect formatting and needs to be replaced.

## MAINTENANCE AND REPAIRS

### MAINTENANCE

Cleaning the luminaire should be done with a soft and dry cloth. It is unacceptable to use detergents, solvents, and other aggressive chemicals.

If the emergency flux achieved is insufficient or when the light source reaches its end of life, the light source shall be replaced with a new one.

If the emergency luminaire does not any longer meet its rated duration of operation after the corresponding (correct and full) recharge period, the ESSS source (battery) must be replaced with a new one.

### REPAIRS AND REPLACEMENTS

Any repairs to the luminaire should only be carried out with the power turned off and the ESSS source (battery) disconnected.

The light source contained in this luminaire shall only be replaced by the manufacturer or his service agent or a similar qualified person.

The ESSS electric source (battery) for safety service is not a user serviceable item and shall only be replaced by the manufacturer service agent or a similar qualified person.



## GUARANTEE

1. The guarantee is provided for a period of 2 years from a date of a purchase. Detailed information can be found on [www.intelight.pl](http://www.intelight.pl) site.
2. The guarantee shall not cover mechanical damage, damage caused by improper installation, operation, or modifications of the luminaire as well as changes occurring due to natural wear and tear of the product.
3. The manufacturer reserves the right to assume no liability for the incorrect operation of the luminaire resulting from interference in the structure of the luminaire carried out by the user without any consent.

## HANDLING OF OBSOLETE EQUIPMENT



Pursuant to the act of 4 July 2012 on waste electrical and electronic equipment (WEEE) and the act of 6 September 2006 on batteries and accumulators and waste batteries and accumulators, this device, after use, due to hazardous substances contained in it, is a subject to collection of waste electrical and electronic equipment. Below there are guidelines for the correct procedure:

1. It is prohibited to place used electrical and electronic equipment together with other waste - this is confirmed by the "crossed-out wheeled bin" marking, which requires selective collection of this type of waste.
2. Electrical and electronic equipment may contain hazardous substances, mixtures, and components which, when released into the environment may pose a serious threat to the health and life of people and living organisms.
3. Waste electrical and electronic equipment, including batteries, should be sent only to authorized collection points, the list of which should be included on the website of each municipal authority.

**intelight**

Intelight Sp. z o.o.  
19, Gwiaździsta str.  
01-651 Warsaw, Poland